

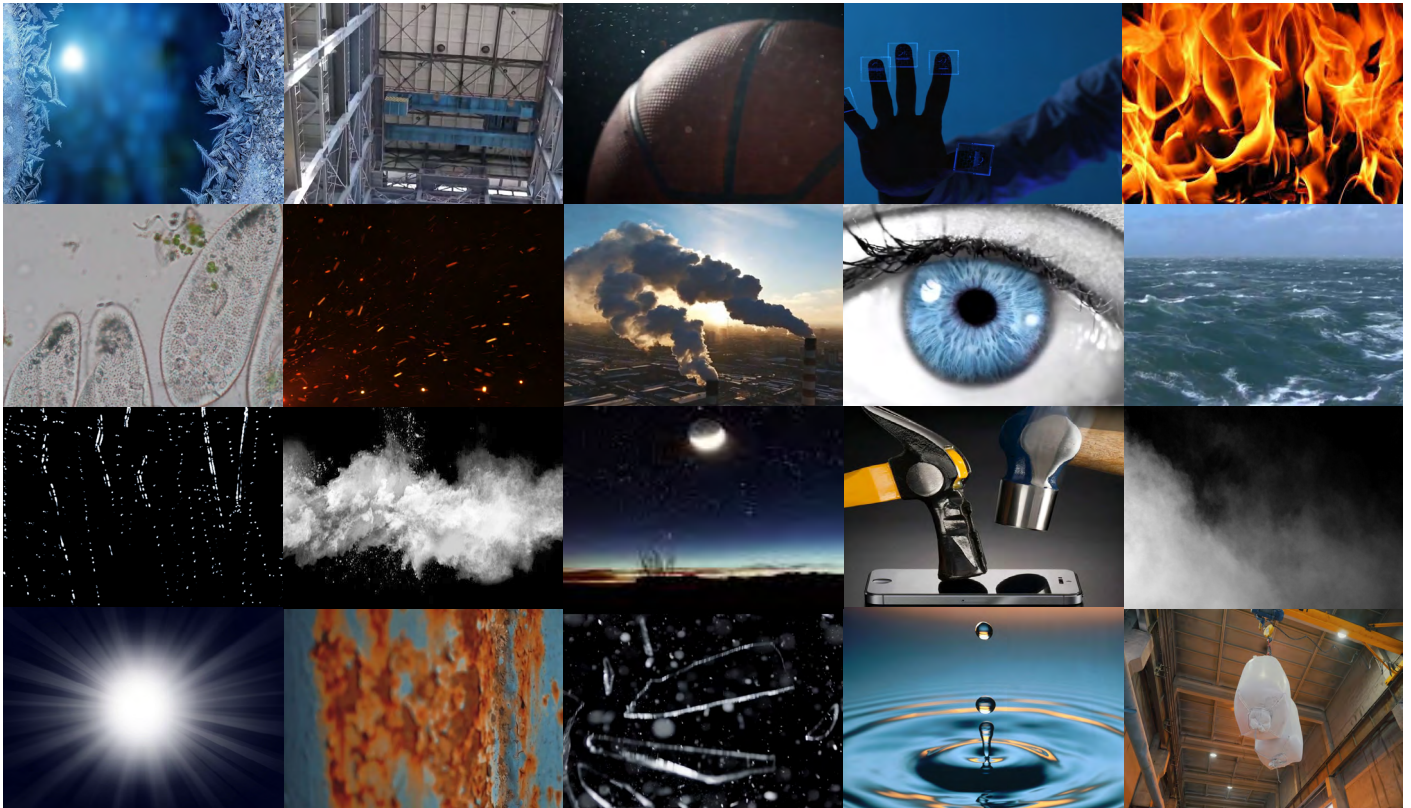

# REVOLVED

Come together experience with next



#challengewithlight

















Whatever your challenge is  
we have a solution  
you are confident in every  
conditions under our light  
because we are  
**engineering the light**













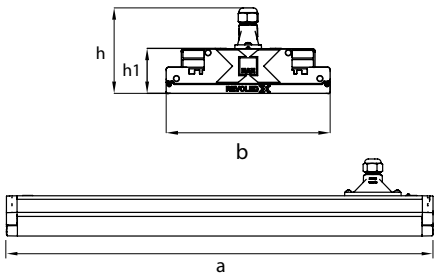
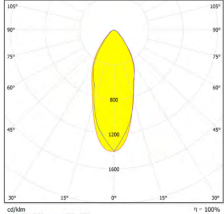
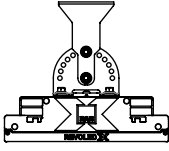

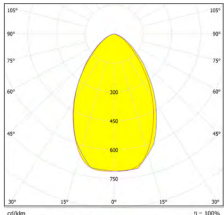
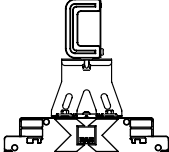

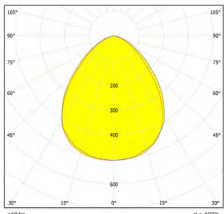
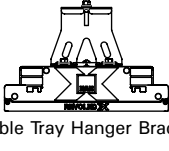

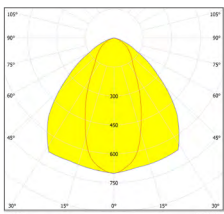
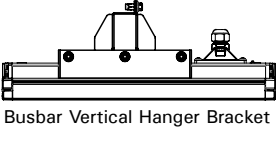
## REVOLED-X HIGH BAY LUMINAIRE

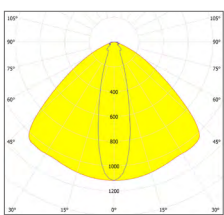
Revoled-X is a new generation Professional lighting solution meeting its experience on the industrial environment lighting of EAE with future Technologies as well as iconic and minimal body design. Offering product options specialized for different environment conditions of industrial facilities, Revoled-X product family guarantees optimum lighting in all industrial facilities with its body designed for maximum strength, optical structure developed specific to application and broad lumen package options. As a result of an engineering solution designed with the latest technology, combining challenging subjects such as high efficiency, perfect light distribution and maximum strength in a compact and slim body makes Revoled-X unique. Based upon "light engineering" principles, our company that reserves a large share to R&D investment initiates a new age together with Revoled-X. EAT Lighting now performs design and manufacturing of its optical lenses that may fully meet the needs of the project needs within its scope. Here it is our new product Revoled-X which meets our experience on the industrial environment lighting with future technologies...

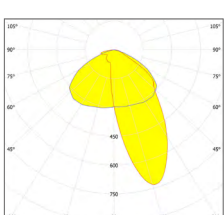
## INDEX

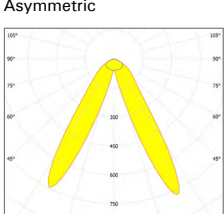
	<b>REVOLED-X GENERAL FEATURES</b>		<b>06</b>
	<b>REVOLED-X HE</b>	175 Lm/W / -20°C - +50°C	<b>14</b>
	<b>REVOLED-X STANDART</b>	165 Lm/W / -20°C - +50°C	<b>15</b>
	<b>REVOLED-X HOT</b>	148 Lm/W / -20°C - +60°C	<b>16</b>
	<b>REVOLED-X HOT PLUS</b>	157 Lm/W / -20°C - +70°C	<b>17</b>
	<b>REVOLED-X COLD</b>	165 Lm/W / -30°C - +45°C	<b>18</b>
	<b>REVOLED-X STERILE</b>	165 Lm/W / -20°C - +50°C Clean room certificated	<b>19</b>
	<b>REVOLED-X SPORT</b>	165 Lm/W / -20°C - +50°C Ball proof certificated	<b>20</b>
	<b>REVOLED-X FOOD</b>	165 Lm/W / -20°C - +50°C Haccp International Food Safety Certification	<b>21</b>
	<b>REVOLED-X EVO</b>	142 Lm/W / -20°C - +40°C	<b>22</b>
	<b>REVOLED-X HE N</b>	176 Lm/W / -20°C - +45°C	<b>23</b>
	<b>REVOLED-X NG</b>	151 Lm/W / -20°C - +40°C	<b>24</b>
	<b>REVOLED-X 50*50 NG</b>	143 Lm/W / -20°C - +40°C	<b>25</b>
	<b>SMARTLOG RF</b>		<b>26</b>
	<b>TESTS AND CERTIFICATES</b>		<b>28</b>

# OVERVIEW

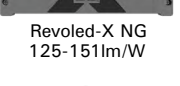
Model	Dimensions	Optic	Lumen	Mounting
 <p>Revoled-X He 156-175lm/W</p>	 <p><b>a x b x h</b>            400 x 200 x 60            600 x 200 x 60            900 x 200 x 60            1200 x 200 x 60            1500 x 200 x 60</p>	 <p>30°</p>	4k lm 8k lm 12k lm 16k lm 20k lm 26k lm 35k lm 42k lm	 <p>Angular Hanger Bracket</p>
 <p>Revoled-X Standart 153-165lm/W</p>		 <p>60°</p>		 <p>Busbar Hanger Bracket</p>
 <p>Revoled-X Hot -20°C... +60°C</p>		 <p>90°</p>		 <p>Cable Tray Hanger Bracket</p>
 <p>Revoled-X Hot -20°C... +70°C</p>		 <p>30°-90°</p>		 <p>Busbar Vertical Hanger Bracket</p>
 <p>Revoled-X Cold -30°C... +45°C</p>		 <p>25°-105°</p>		
 <p>Revoled-X Sterile Temiz Oda Sertifikasi</p>		 <p>Asymmetric</p>		
 <p>Revoled-X Sport Ball Prof Sertifika</p>		 <p>Double Asymmetric</p>		
 <p>Revoled-X Food HACCP Sertifika</p>				
 <p>Revoled-X Evo 125-176lm/W</p>				
 <p>Revoled-X HE NG 164-176lm/W</p>				
 <p>Revoled-X NG 125-151lm/W</p>				
 <p>Revoled-X NG 50*50 138-143lm/W</p>				

## SELECTION TABLE

MODEL	Lm/W	LUMEN	OPTIC	GLARE	AMBIENT TEMPERATURE
REVOLED-X HE	156-175 Lm/W	4k lm 8k lm 12k lm 16k lm 20k lm	30° Narrow angle 60° Arena 90° Lowbay 30°x90° Raf 25°x105° Raf (Narrow angle) Asymmetric Double Asymmetric	UGR < 19 UGR < 22 UGR > 22 UGR > 22 UGR > 25	-20°C... + 50°C
REVOLED-X STANDART	153-165 Lm/W	4k lm 8k lm 12k lm 16k lm 20k lm	30° Narrow angle 60° Arena 90° Lowbay 30°x90° Raf 25°x105° Raf (Narrow angle) Asymmetric Double Asymmetric	UGR < 19 UGR < 22 UGR > 22 UGR > 22 UGR > 25	-20°C... + 50°C
REVOLED-X HOT	137-148 Lm/W	4k lm 8k lm 12k lm 16k lm 20k lm	30° Narrow angle 60° Arena 90° Lowbay 30°x90° Raf 25°x105° Raf (Narrow angle) Asymmetric Double Asymmetric	UGR < 19 UGR < 22 UGR > 22 UGR > 22 UGR > 25	-20°C... + 60°C
REVOLED-X HOT PLUS	144-157 Lm/W	4k lm 8k lm 12k lm 16k lm 20k lm	30° Narrow angle 60° Arena 90° Lowbay 30°x90° Raf 25°x105° Raf (Narrow angle) Asymmetric Double Asymmetric	UGR < 19 UGR < 22 UGR > 22 UGR > 22 UGR > 25	-20°C... + 70°C
REVOLED-X COLD	150-165 Lm/W	4k lm 8k lm 12k lm 16k lm 20k lm	30° Narrow angle 60° Arena 90° Lowbay 30°x90° Raf 25°x105° Raf (Narrow angle) Asymmetric Double Asymmetric	UGR < 19 UGR < 22 UGR > 22 UGR > 22 UGR > 25	-30°C... + 45°C
REVOLED-X STERILE	150-165 Lm/W	4k lm 8k lm 12k lm 16k lm 20k lm	30° Narrow angle 60° Arena 90° Lowbay 30°x90° Raf 25°x105° Raf (Narrow angle) Asymmetric Double Asymmetric	UGR < 19 UGR < 22 UGR > 22 UGR > 22 UGR > 25	-20°C... + 50°C
REVOLED-X SPORT	150-165 Lm/W	4k lm 8k lm 12k lm 16k lm 20k lm	30° Narrow angle 60° Arena 90° Lowbay 30°x90° Raf 25°x105° Raf (Narrow angle) Asymmetric Double Asymmetric	UGR < 19 UGR < 22 UGR > 22 UGR > 22 UGR > 25	-20°C... + 50°C
REVOLED-X FOOD	150-165 Lm/W	4k lm 8k lm 12k lm 16k lm 20k lm	30° Narrow angle 60° Arena 90° Lowbay 30°x90° Raf 25°x105° Raf (Narrow angle) Asymmetric Double Asymmetric	UGR < 19 UGR < 22 UGR > 22 UGR > 22 UGR > 25	-20°C... + 50°C
REVOLED-X EVO	125-176 Lm/W	9k lm 17k lm 26k lm 35k lm 42k lm	30° Narrow angle 60° Arena 90° Lowbay 30°x90° Raf 25°x105° Raf (Narrow angle) Asymmetric Double Asymmetric	UGR < 19 UGR < 22 UGR > 22 UGR > 22 UGR > 25	-20°C... + 40°C

<b>REVOLED-X HE NG</b>	164-176 Lm/W	8k lm 13k lm 19k lm 22k lm 28k lm 33k lm	30° Narrow angle 60° Arena 90° Lowbay 30°x90° Raf 25°x105° Raf (Narrow angle)	UGR < 19 UGR < 22 UGR > 22 UGR > 22 UGR > 25	-20°C... + 45°C
<b>REVOLED-X NG</b>	125-151 Lm/W	9k lm    19k lm 12k lm    21k lm 15k lm    33k lm 17k lm    42k lm	60° Arena 90° Lowbay	UGR < 22 UGR < 22	-20°C... + 40°C
<b>REVOLED-X NG 50*50</b>	138-143 Lm/W	9k lm    26k lm 13k lm    33k lm 19k lm    37k lm 21k lm    40k lm	60° Arena 90° Lowbay	UGR < 22 UGR < 22	-20°C... + 40°C

# OPTICAL MODELS

**30° NARROW ANGLE**

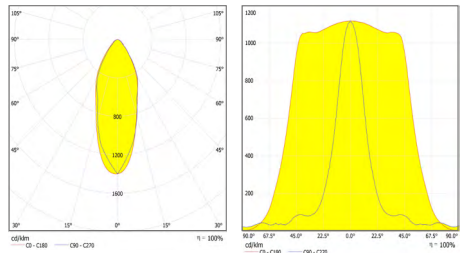
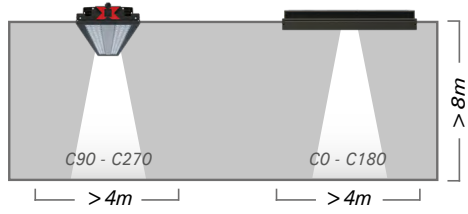

**60° ARENA**

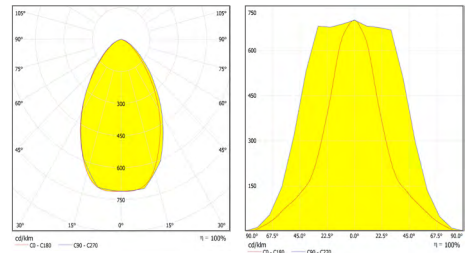
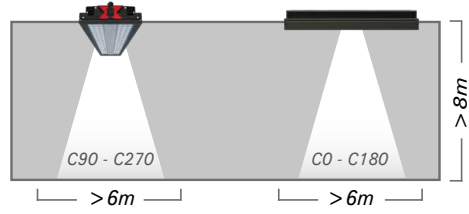

**90° LOWBAY**

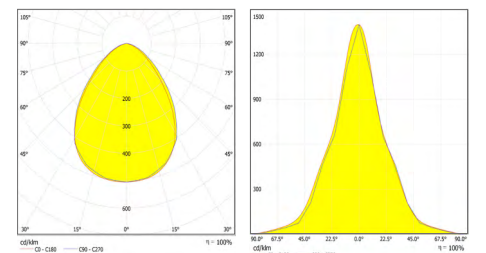
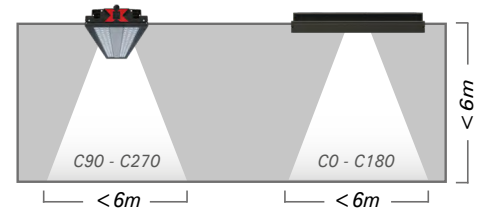

**30° - 90° RAF**

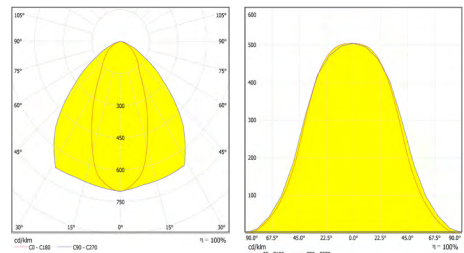
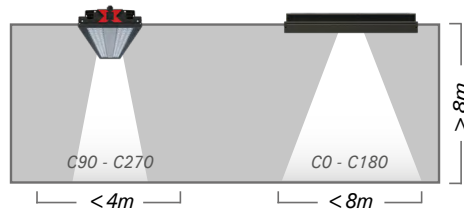

**25° - 105° RAF (NARROW ANGLE)**

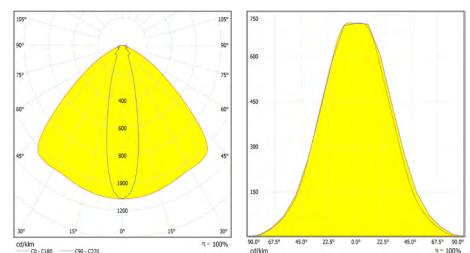
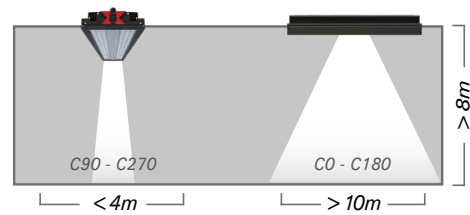

**ASYMMETRIC**

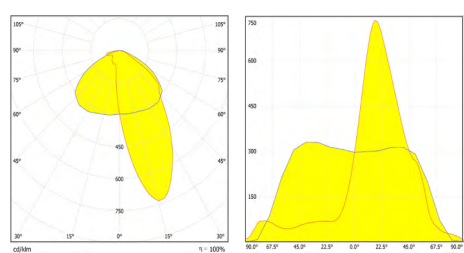
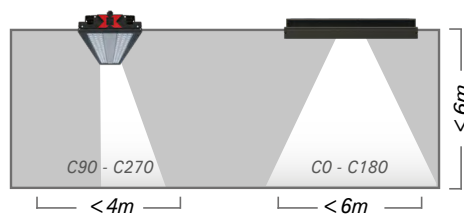

**DOUBLE ASYMMETRIC**

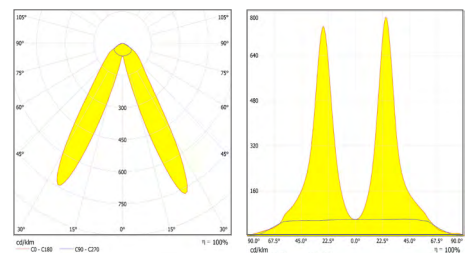
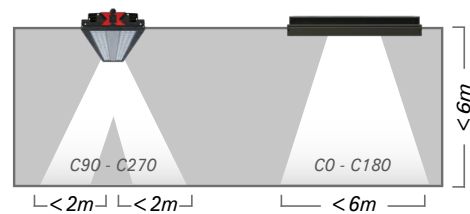



# ASSEMBLY AND HANGER DETAILS

REVOLED-X BARA 90° HANGER SET

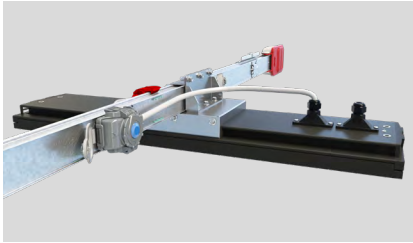

ORDER COD: 3200379

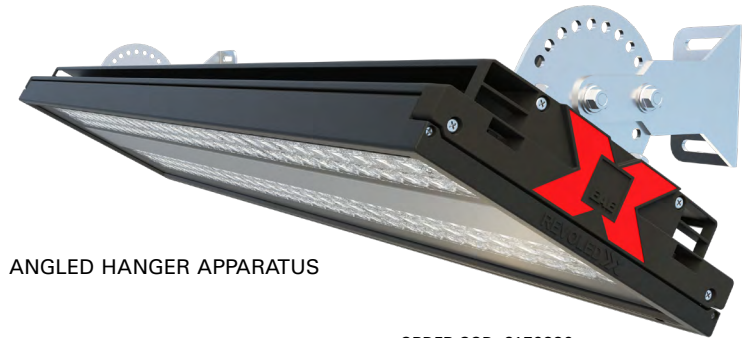

ANGLED HANGER APPARATUS

ORDER COD: 3179886

SECURITY/SEISMIC HANGER APPARATUS\*

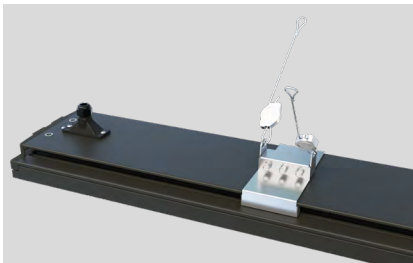

ORDER COD: 3197123

\*The Security / Seismic suspension apparatus is not suitable for use alone. It should be used with busbar / cable channel or other suspension systems.

BUSBAR HANGER APPARATUS

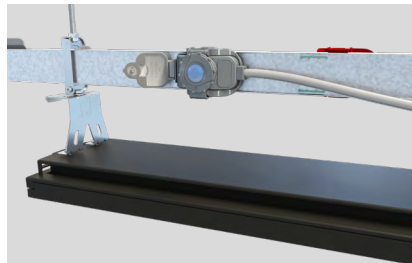

ORDER COD: 3179883

CABLE CHANNEL HANGER APPARATUS

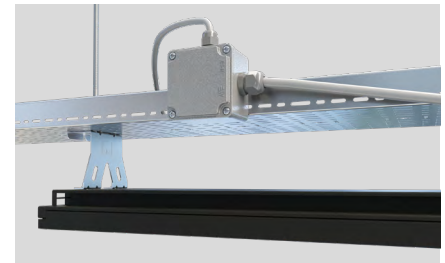

ORDER COD: 3179885

## CHANNEL CONNECTION

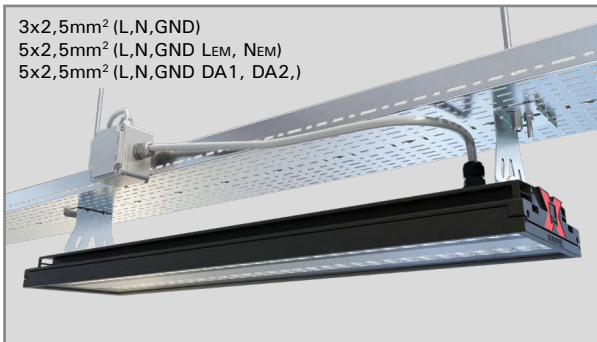

TG: SINGLE ENTRY

R V X               T G

## BUSBAR CONNECTION



CG: DOUBLE ENTRY

R V X              C G

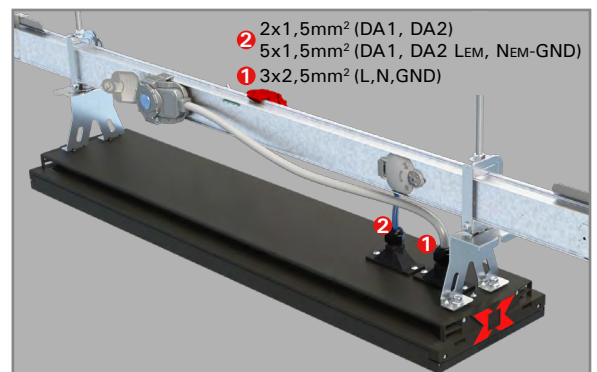



**IP66 Aluminum body**  
Perfect thermal performance

**Silicone gasket, sealing gasket**  
Long-lasting, anti-deformation



**Europe-origin driver**  
PF > 0,95 75-165W  
ENEC certificate



**Aluminum cover cap**

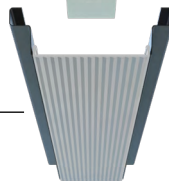

**Aluminum PCB**  
> 200lm/W > 100.000h  
LED

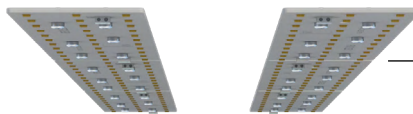

**Modular optical lens 300, 600, 900,  
300x900, 250x1050, AS, DA**  
EAE, domestic design & Production  
Optics



**Tempered film-coated transparent  
glass, aluminum flip-open frame**  
Impact resistance IK09

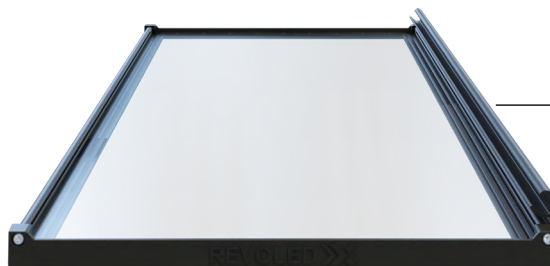

# — Revoled-X —

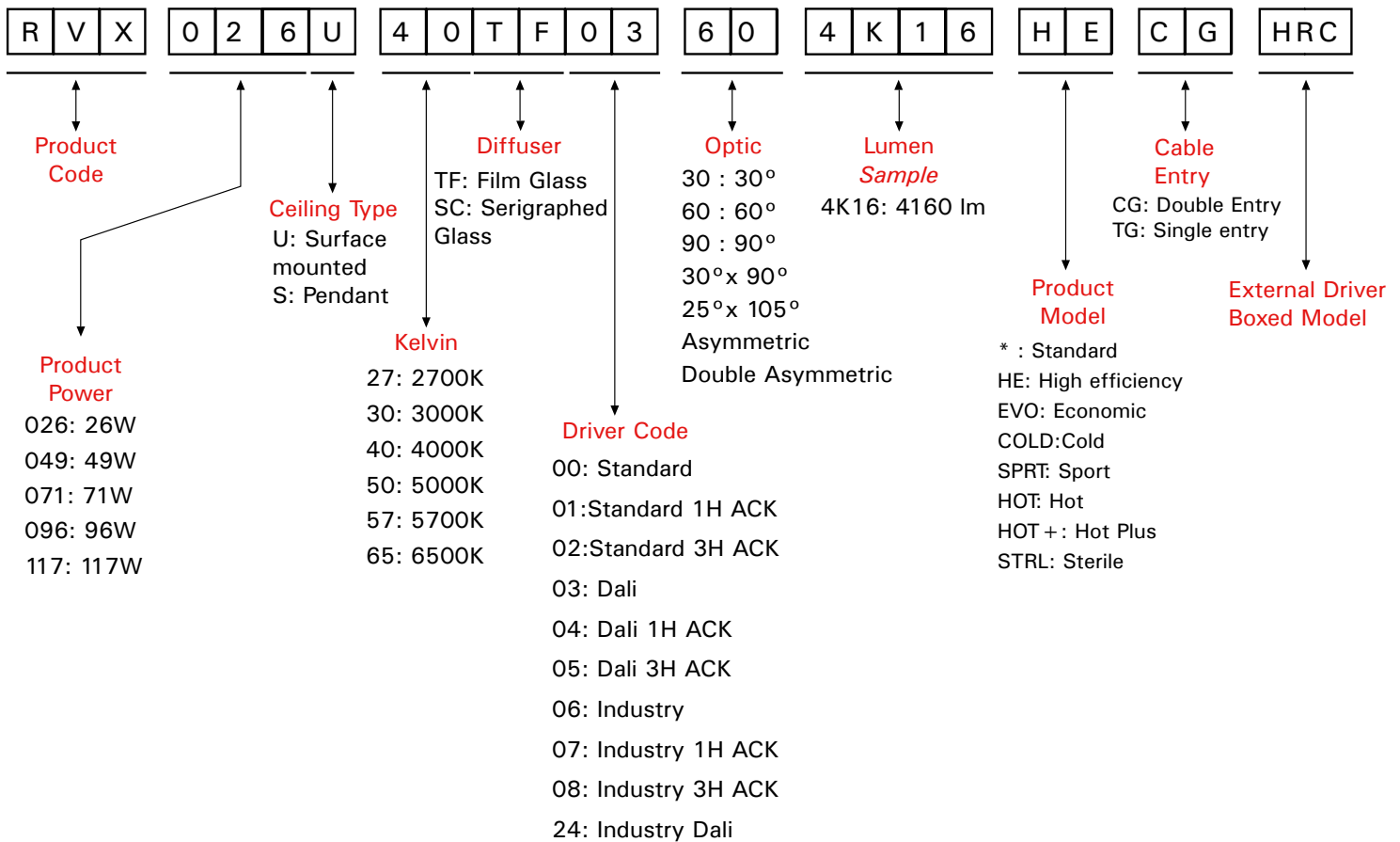

## WHY REVOLED-X?



### Long Life

LED light resources have 2-3 times longer life than florescent bulbs, 6-8 times longer than metal halide bulbs.



### Instant Burning and Light Control Possibilities

In case of power outage, 5-10 regime period of 5-10 min. required for relighting creates a major problem for the businesses and magnetic ballasts which cannot be dimmed do not offer opportunity for automation in high pressure armatures.



### Stable Light Level

While high pressure armatures and Florescent armatures cause 50% and 20% light loss towards the end of their life, respectively, Revoled-X armature creates a maximum loss of 10%.



### Energy Saving

Revoled-X ensures 77% energy saving compared to metal halide armatures, 58% compared to Florescent high ceiling armatures with its efficiency value starting from 140lm/W to 170 lm/W.



## Eco-Friendly

Mercury, known as a toxic gas, is available in a certain amount in high pressure and fluorescent lamps. There is no mercury gas in LED light sources.



## Smooth Operation

Difficulty in intervention required to be carried out due to bulb malfunctions especially in high ceilings can be overcome with LED armatures.



## High Color Rendering

Revoled-X armatures have a high CRI (color rendering ratio) value of > 80 like fluorescent armatures. This is especially important for businesses such as the textile industry where CRI value is important.



## Occupational Safety

The fact that armature body structure is impact resistant and does not disconnect from the armature even if diffuser is broken and prevents accumulation of dust and particle in the body shows that it complies with the criteria of occupational safety.

# REVOLED-X HE

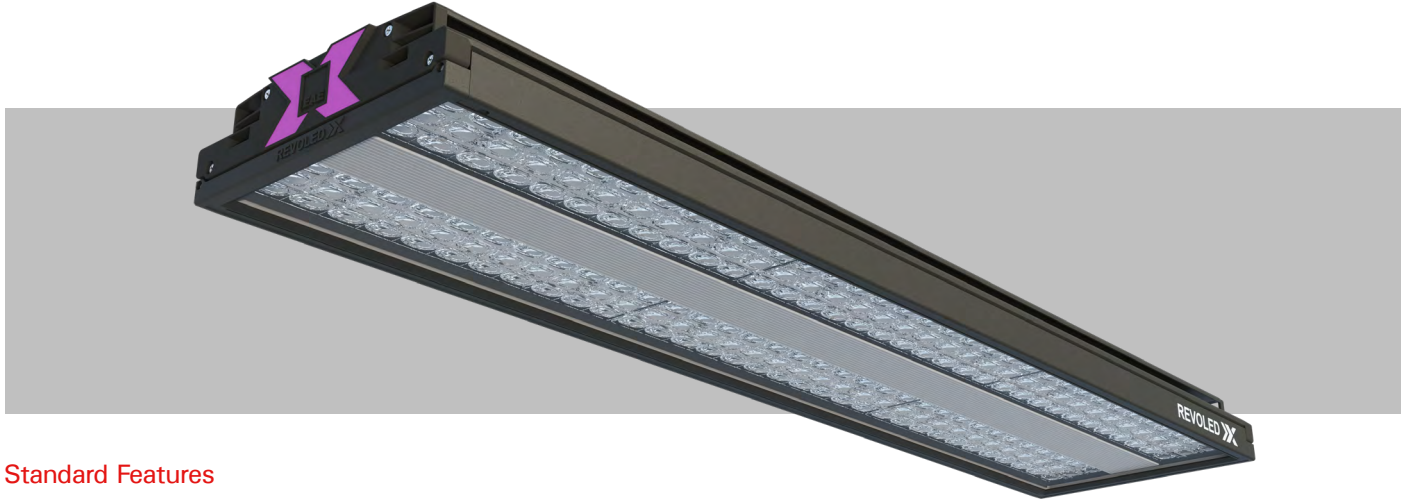

## Standard Features

Housing	Aluminium profile housing
Diffuser	Tempered glass with security film
Optic	AS / DA / 30°x90° / 30° / 60° / 90° / 25x105°
IP	IP65 / IP66
Installation	Surface mounted
Light Source	LED

## Optical & Electrical Features

Power	26W / 50W / 71W / 96W / 117W
Lumen	4080lm / 8423lm / 12352lm / 16549lm / 20566lm
Efficacy	156 - 175lm/W
Input Voltage	220-240 V
Frequency	50-60 Hz
Power Factor	> 0,9
Color Temperature	3000K / 4000K / 5700K / 6500K
CRI	> 80

\*Technical specifications have ± 10 tolerance.

## Other Features & Conditions

Operating Temperature	-20°C / +50°C
Operating Temperature (ACK*)	+5°C / +35°C
Impact Resistance	IK07 / IK08 / IK09
LED Lifetime - L70	> 102.000 hour @Ta = 50 °C

\*Temperature values vary according to wattage values.

## Optional Features

Color temperature	3000K / 5700K / 6500K
Emergency Kit Options	1-3 hour
DALI Option	Yes



## Technical Drawing

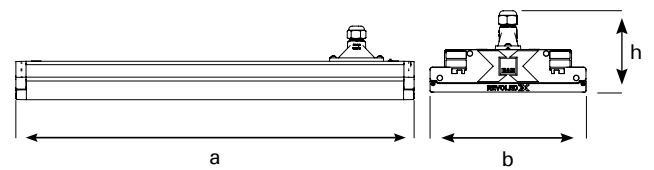

## Dimensions (mm)

	a	b	h
<b>26W</b>	493	209	109
<b>50W</b>	950	209	109
<b>71W</b>	1030	209	109
<b>96W</b>	1176	209	109
<b>117W</b>	1462	209	109



-20°C +50°C

# REVOLED-X STANDART

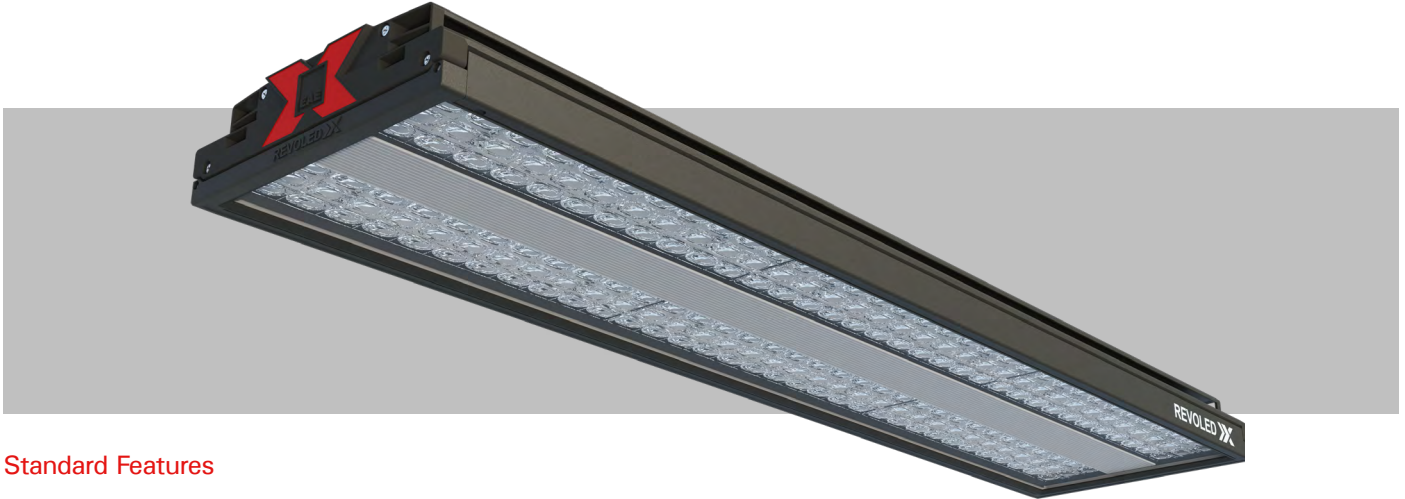

## Standard Features

Housing	Aluminium profile housing
Diffuser	Tempered glass with security film
Optic	AS / DA / 30°x90° / 30° / 60° / 90° / 25x105°
IP	IP65 / IP66
Installation	Surface mounted / Sarkit
Light Source	Mid Power LED

## Optical & Electrical Features

Power	28W / 53W / 77W / 103W / 128W
Lumen	4163lm / 8481lm / 12760 lm / 16363lm / 21078lm
Efficacy	153 - 165lm/W
Input Voltage	220-240 V
Frequency	50-60 Hz
Power Factor	> 0,9
Color Temperature	4000K / 5700K / 6500K
CRI	>80

\*Technical specifications have ± 10 tolerance.

## Other Features & Conditions

Operating Temperature	-20°C / +50°C
Operating Temperature (ACK*)	+5°C / +35°C
Impact Resistance	IK07 / IK08 / IK09
LED Lifetime - L70	> 102.000 hour @Ta= 50 °C

\*Temperature values vary according to wattage values.

## Optional Features

Color temperature	3000K / 5700K / 6500K
Emergency Kit Options	1-3 hour
DALI Option	Yes



## Technical Drawing

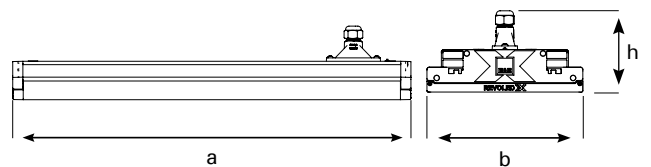

## Dimensions (mm)

	a	b	h
<b>28W</b>	493	209	109
<b>53W</b>	950	209	109
<b>77W</b>	1030	209	109
<b>103W</b>	1176	209	109
<b>128W</b>	1462	209	109



# REVOLED-X HOT

-20°C +60°C

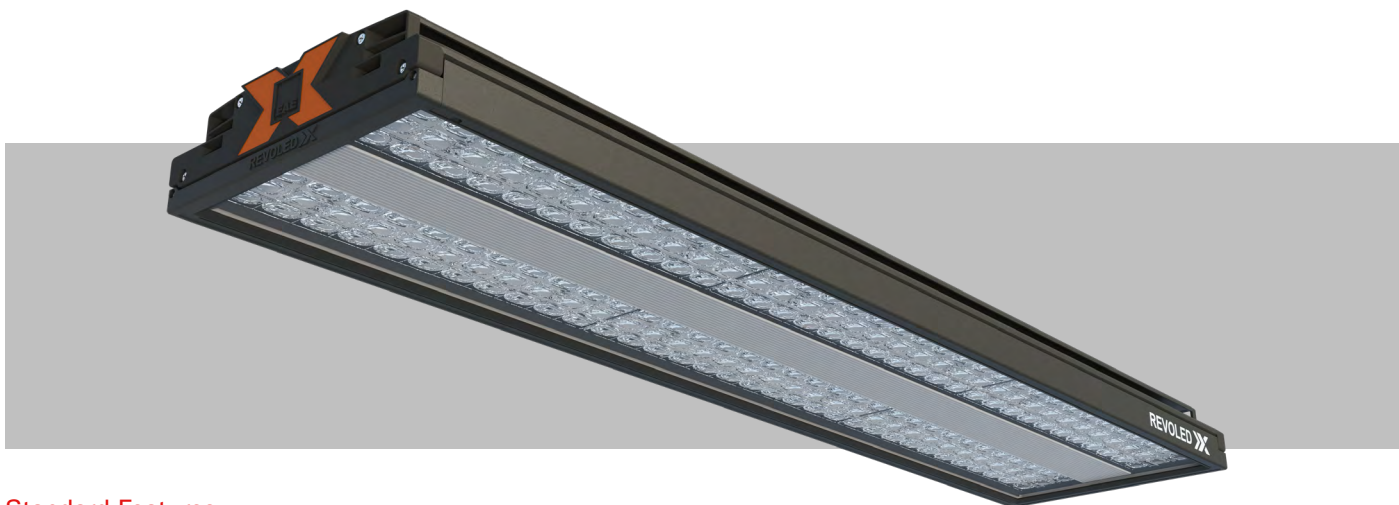

## Standard Features

Housing	Aluminium profile housing
Diffuser	Tempered glass with security film
Optic	AS / DA / 30°x 90°/ 30°/ 60°/ 90° / 25x105°
IP	IP66
Installation	Surface mounted
Light Source	Mid Power LED

## Optical & Electrical Features

Power	28W / 53W / 77W / 103W / 128W
Lumen	4294lm / 8481lm / 12760lm / 16041lm / 21078lm
Efficacy	150 - 160lm/W
Input Voltage	220-240 V
Frequency	50-60 Hz
Power Factor	> 0,9
Max. Gerilim Dayanımı	4 kV
Color Temperature	3000K / 4000K / 5700K / 6500K
CRI	>80

\*Technical specifications have ± 10 tolerance.

## Other Features & Conditions

Operating Temperature	-20°C / +60°C
Operating Temperature (ACK*)	+5 °C / +35°C
Impact Resistance	IK07/ IK08 / IK09
LED Lifetime - L70	> 102.000 hour @Ta= 60 °C

\*Temperature values vary according to wattage values.

## Optional Features

Color temperature	3000K / 5700K / 6500K
Emergency Kit Options	1-3 hour
DALI Option	Yes



## Technical Drawing

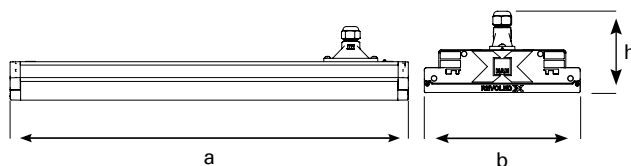

## Dimensions (mm)

	a	b	h
<b>28W</b>	1028	209	109
<b>53W</b>	950	209	109
<b>77W</b>	1030	209	109
<b>103W</b>	1176	209	109
<b>128W</b>	1462	209	109





-20°C +70°C  
Dali version -20/+65

# REVOLED-X HOT PLUS

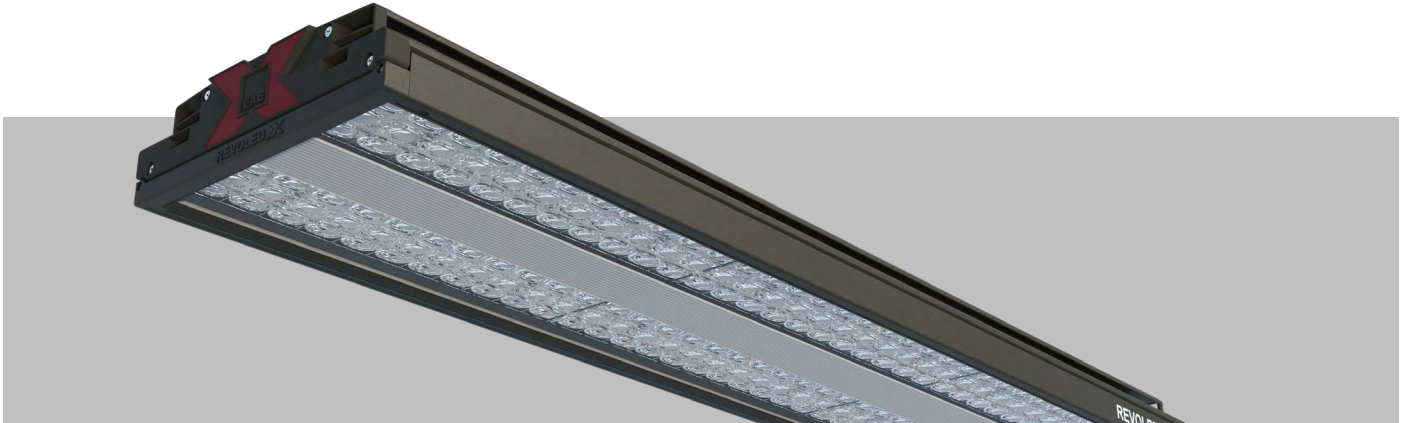

## Standard Features

Housing	Aluminium profile housing
Diffuser	Tempered glass with security film
Optic	AS / DA / 30°x 90°/ 30°/ 60°/ 90° / 25x105°
IP	IP66
Installation	Surface mounted
Light Source	LED

## Optical & Electrical Features

Power	26W / 49W / 70W / 95W / 117W
Lumen	3749lm / 7415lm / 11115lm / 14501lm / 17988lm
Efficacy	144 - 157lm/W
Input Voltage	220-240 V
Frequency	50-60 Hz
Power Factor	> 0,9
Max. Gerilim Dayanımı	4 kV
Color Temperature	4000K
CRI	>80

\*Technical specifications have ± 10 tolerance.

## Other Features & Conditions

Operating Temperature	-20°C / +70°C
Dali Versiyonu	-20°C / +65°C
Operating Temperature (ACK*)	+5°C / +35°C
Impact Resistance	IK07/ IK08 / IK09
LED Lifetime - L70	> 102.000 hour @Ta = 70 °C

\*Temperature values vary according to wattage values.

## Optional Features

Color temperature	3000K / 5700K / 6500K
Emergency Kit Options	1-3 hour
DALI Option	Yes



## Technical Drawing

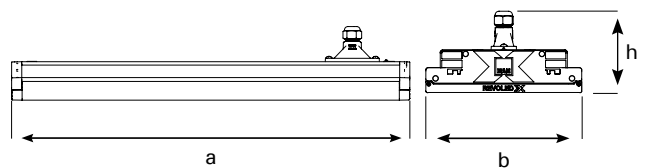

## Dimensions (mm)

	a	b	h
26W	602	209	109
49W	1028	209	109
70W	1030	209	109
95W	1176	209	109
117W	1462	209	109



# REVOLED-X COLD

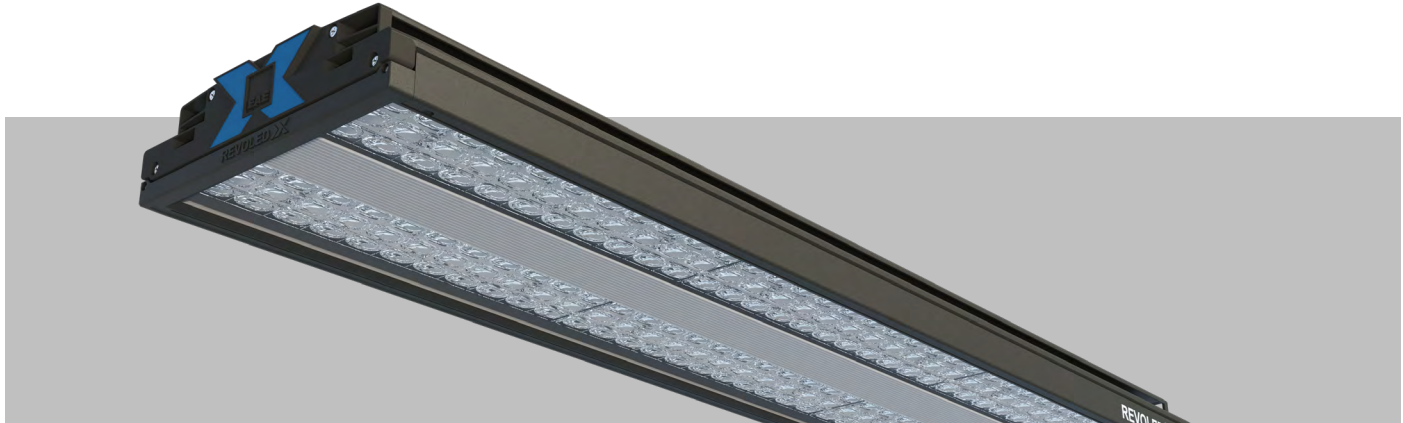

## Standard Features

Housing	Aluminium profile housing
Diffuser	Tempered glass with security film
Optic	AS / DA / 30°x 90° / 30° / 60° / 90° / 25x105°
IP	IP66
Installation	Surface mounted
Light Source	Mid Power LED

## Optical & Electrical Features

Power	28W / 53W / 77W / 103W / 128W
Lumen	4294lm / 8481lm / 12760 lm / 16041lm / 20606lm
Efficacy	153 - 165lm/W
Input Voltage	220-240 V
Frequency	50-60 Hz
Power Factor	> 0,9
Color Temperature	4000K / 5700K / 6500K
CRI	>80

\*Technical specifications have ± 10 tolerance.

## Other Features & Conditions

Operating Temperature	-30°C / +45°C
Operating Temperature (ACK*)	+5°C / +35°C
Impact Resistance	IK07 / IK08 / IK09
LED Lifetime - L70	> 102.000 hour @Ta = 50 °C

\*Temperature values vary according to wattage values.

## Optional Features

Color temperature	3000K / 5700K / 6500K
Emergency Kit Options	1-3 hour
DALI Option	Yes



## Technical Drawing

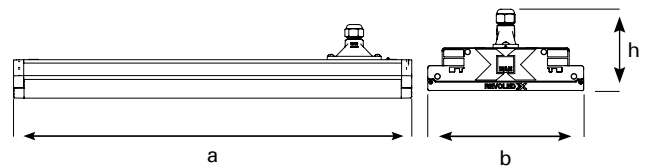

## Dimensions (mm)

	a	b	h
<b>28W</b>	493	209	109
<b>53W</b>	950	209	109
<b>77W</b>	1030	209	109
<b>103W</b>	1176	209	109
<b>128W</b>	1462	209	109

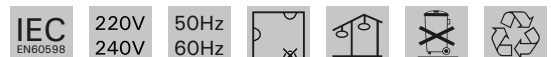

-20°C +50°C

# REVOLED-X STERILE

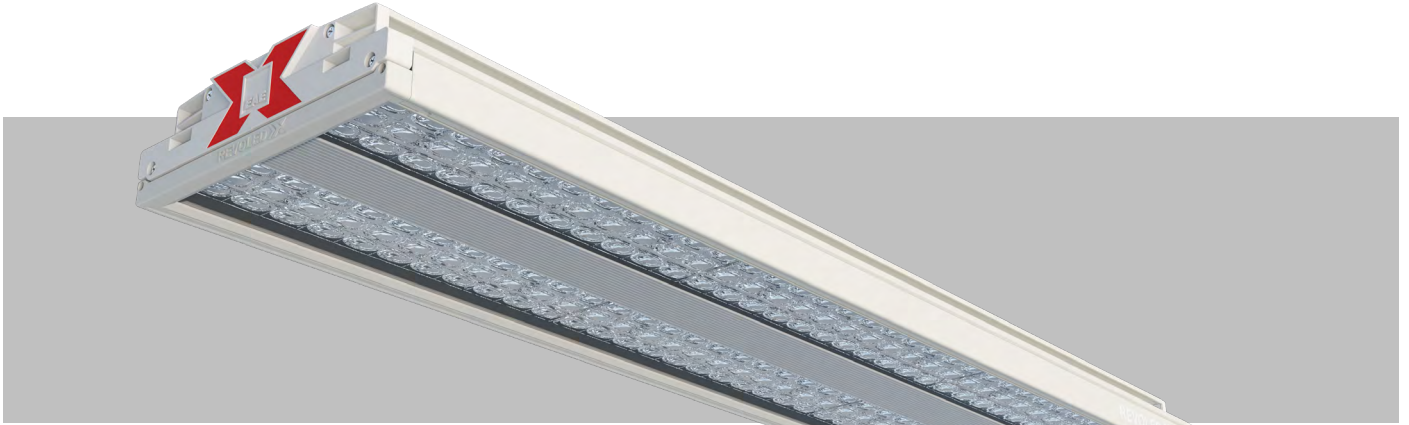

## Standard Features

Housing	Aluminium profile housing
Diffuser	Tempered glass with security film
Optic	30° / 60° / 90° / 30°x90° / 25°x105° / AS / DA
IP	IP65 / IP66
Installation	Surface mounted
Light Source	LED

## Optical & Electrical Features

Tüketim Gücü	28W / 53W / 77W / 103W / 128W
Lumen	4294lm / 8481lm / 12760lm / 16041lm / 20606lm
Armatür Verimliliği	150 - 165lm/W
Input Voltage	220-240 V
Giriş FColourans	50-60 Hz
Güç Faktörü	> 0,9
Color Temperature	3000K / 4000K / 5700K / 6500K
CRI	> 80

\*Technical specifications have ± 10 tolerance.

## Other Features & Conditions

Operating Temperature	-20°C / +50°C
Operating Temperature (ACK*)	+5°C / +35°C
Impact Resistance	IK07 / IK08 / IK09
LED Lifetime - L70	> 102.000 hour @Ta= 50 °C
Colour	RAL 9010 Antibacterial

\*Temperature values vary according to wattage values.

## Optional Features

Color temperature	3000K / 5700K / 6500K
Emergency Kit Options	1-3 hour
DALI Option	Yes



## Technical Drawing

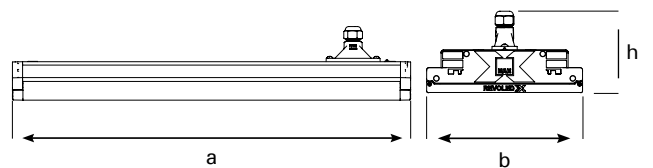

## Dimensions (mm)

	a	b	h
<b>28W</b>	493	209	109
<b>53W</b>	950	209	109
<b>77W</b>	1030	209	109
<b>103W</b>	1176	209	109
<b>128W</b>	1462	209	109



# REVOLED-X SPORT

-20°C +50°C

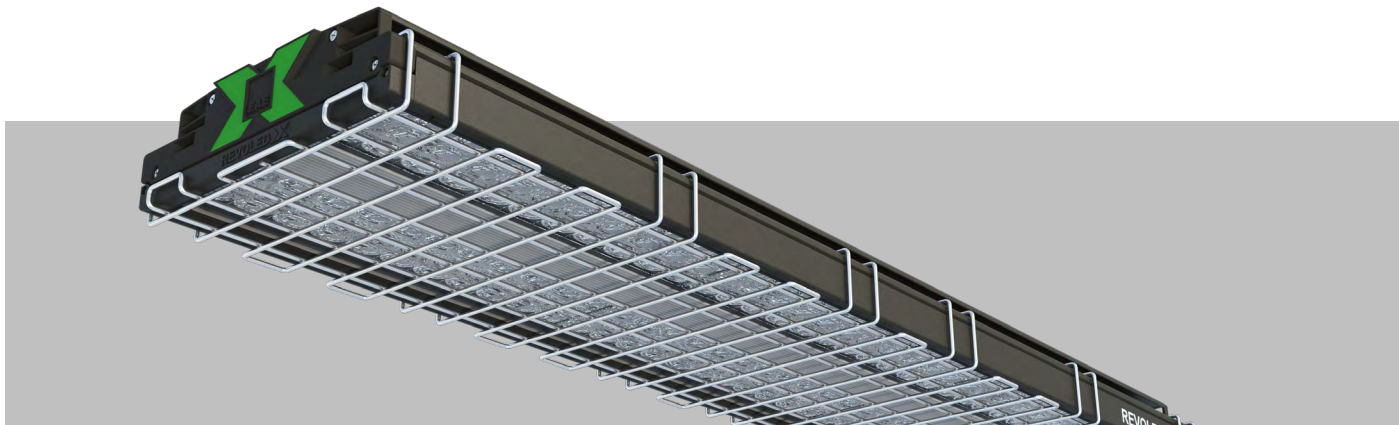

## Standard Features

Housing	Aluminium profile housing
Diffuser	Protection film and protective wire mesh + Tempered glass
Optic	30° / 60° / 90° / 30°x 90° / 25° x 105°
IP	IP65 / IP66
Installation	Surface mounted
Light Source	LED

## Optical & Electrical Features

Power	28W / 53W / 77W / 103W / 128W
Lumen	4294lm / 8481lm / 12760lm / 16041lm / 20606lm
Efficacy	152 - 165lm/W
Input Voltage	220-240 V
Frequency	50-60 Hz
Power Factor	> 0,9
Color Temperature	3000K / 4000K / 5700K / 6500K
CRI	> 80

\*Technical specifications have ± 10 tolerance.

## Other Features & Conditions

Operating Temperature	-20°C / +50°C
Operating Temperature (ACK*)	+5°C / +35°C
Impact Resistance	IK10
LED Lifetime - L70	> 102.000 hour @Ta= 50 °C

\*Temperature values vary according to wattage values.

## Optional Features

Color temperature	3000K / 5700K / 6500K
Emergency Kit Options	1-3 hour
DALI Option	Yes



Technical Drawing

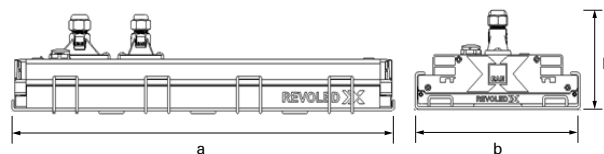

## Dimensions (mm)

	a	b	h
<b>28W</b>	501	209	115
<b>53W</b>	957	209	115
<b>77W</b>	1037	209	115
<b>103W</b>	1183	209	115
<b>128W</b>	1470	209	115



-20°C +50°C

# REVOLED-X

## FOOD



### Standard Features

Housing	Aluminium profile housing, RAL 9003 Antibacterial painted
Diffuser	Tempered glass with security film
Optic	30° / 30° x 90° / 60° / 90°
IP	IP66
Installation	Surface mounted
Light Source	LED

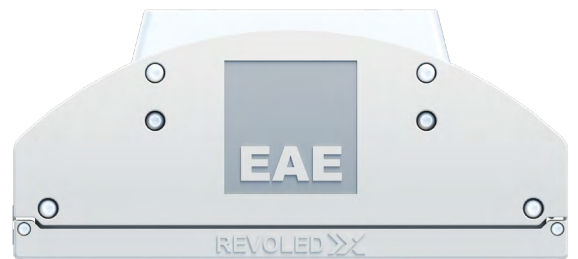

### Optical & Electrical Features

Power	28W / 53W / 77W / 103W / 128W
Lumen	4294lm / 8000lm / 13000lm / 16000lm / 21078lm
Efficacy	150 - 165lm/W
Input Voltage	220-240 V
Frequency	50-60 Hz
Power Factor	> 0,9
Color Temperature	3000K / 4000K / 5000K / 5700K / 6500K
CRI	> 80

### Technical Drawing

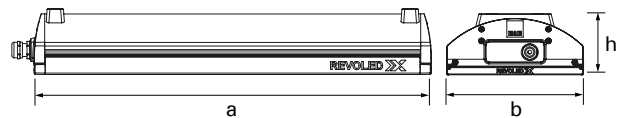

\*Technical specifications have ± 10 tolerance.

### Other Features & Conditions

Operating Temperature	-20°C / +50°C
Operating Temperature (ACK*)	+5°C / +35°C
Impact Resistance	IK07 / IK08 / IK09
LED Lifetime - L70	> 102.000 hour @Ta = 50 °C

\*Temperature values vary according to wattage values.

### Dimensions (mm)

	a	b	h
<b>28W</b>	454	209	93
<b>53W</b>	980	209	93
<b>77W</b>	1060	209	93
<b>103W</b>	1207	209	93
<b>128W</b>	1494	209	93

### Optional Features

Color temperature	3000K / 5700K / 6500K
Emergency Kit Options	1-3 hour
DALI Option	Yes



# REVOLED-X EVO

-20°C +40°C

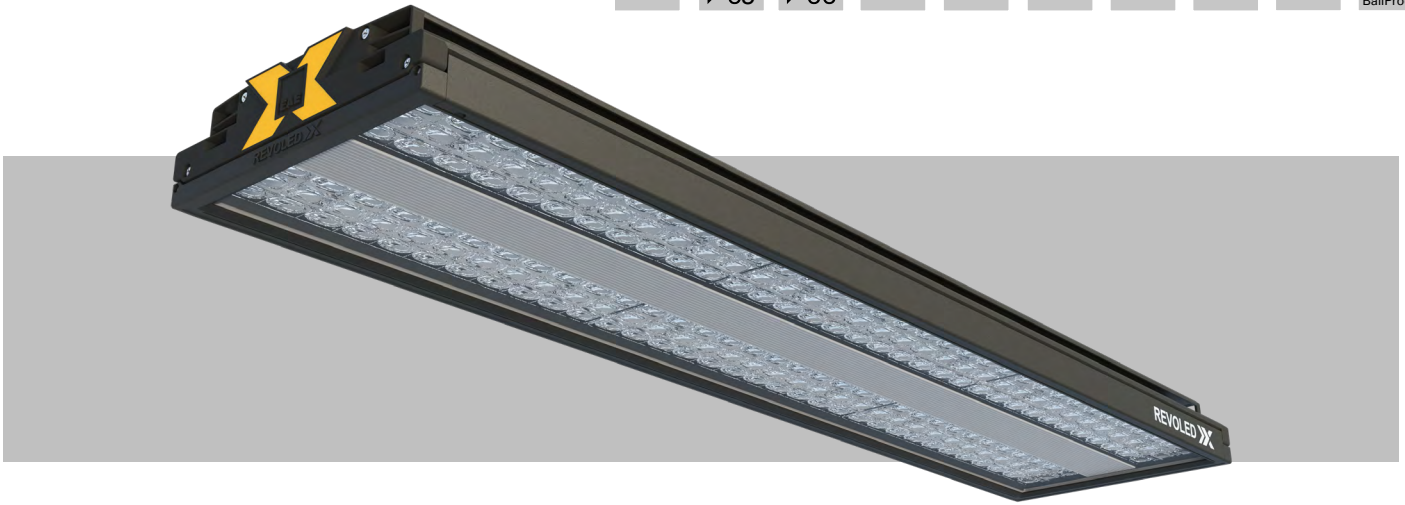

## Standard Features

Housing	Aluminium profile housing
Diffuser	Tempered glass with security film
Optic	AS / DA / 30°x 90° / 30° / 60° / 90° / 25x105°
IP	IP65 / IP66
Installation	Surface mounted
Light Source	LED



## Optical & Electrical Features

Power	67,78W / 90,67W / 131,07W / 142,93W / 196,2W / 232,94W / 260,69W / 337,17W
Lumen	9235lm / 12101lm / 17618lm / 19896lm / 27177lm / 33141lm / 35971lm / 42102lm
Efficacy	125 - 142lm/W
Input Voltage	220-240 V
Frequency	50-60 Hz
Power Factor	> 0,9
Color Temperature	4000K
CRI	>80

## Technical Drawing

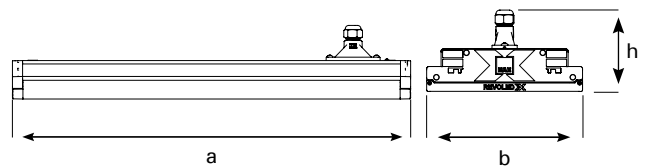

## Dimensions (mm)

	a	b	h
<b>67,78W</b>	975	209	109
<b>90,67W</b>	1120	209	109
<b>131,07W</b>	900	209	109
<b>142,93W</b>	1120	209	109
<b>196,2W</b>	1473	209	109
<b>232,94W</b>	1186	209	109
<b>260,69W</b>	1583	209	109
<b>337,17W</b>	2013	209	109

\*Technical specifications have ± 10 tolerance.

## Other Features & Conditions

Operating Temperature	-20°C / +40°C
Operating Temperature (ACK*)	+5°C / +35°C
Impact Resistance	IK07 / K08 / K09
LED Lifetime - L70	> 72.000 hour @Ta= 40 °C

\*Temperature values vary according to wattage values.

## Optional Features

Color temperature	3000K / 5700K / 6500K
Emergency Kit Options	1-3 hour
DALI Option	Yes



-20 °C +45 °C

# REVOLED-X

## HE NG



### Standard Features

Housing	Aluminium Extrusion Housing
Diffuser	Tempered glass
Optic	30°x 90° / 30° / 60° / 90° / 25x105°
IP	IP65
Installation	Surface mounted
Light Source	LED

### Optical & Electrical Features

Power	53W / 80W / 113W / 126W / 164W / 196W
Lumen	8729lm / 13094lm / 19732lm / 22198lm / 28399lm / 33265lm
Efficacy	164 - 176lm/W
Input Voltage	220-240 V
Frequency	50-60 Hz
Power Factor	> 0,9
Color Temperature	4000K
CRI	> 80

\*Technical specifications have ± 10 tolerance.

### Other Features & Conditions

Operating Temperature	-20°C / +45°C
Operating Temperature (ACK*)	+5°C / +35°C
Impact Resistance	IK07 / IK08 / IK09
LED Lifetime - L70	> 72.000 hour @Ta = 40 °C

\*Temperature values vary according to wattage values.

### Optional Features

Color temperature	3000K / 5000K / 5700K / 6500K
Emergency Kit Options	1-3 hour
DALI Option	Yes



### Technical Drawing

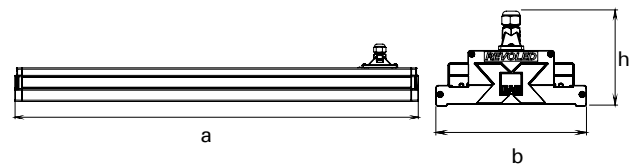

### Dimensions (mm)

	a	b	h
<b>53W</b>	975	203	111
<b>80W</b>	613	203	111
<b>113W</b>	1120	203	111
<b>126W</b>	900	203	111
<b>164W</b>	1120	203	111
<b>196W</b>	1186	203	111



# REVOLED-X NG

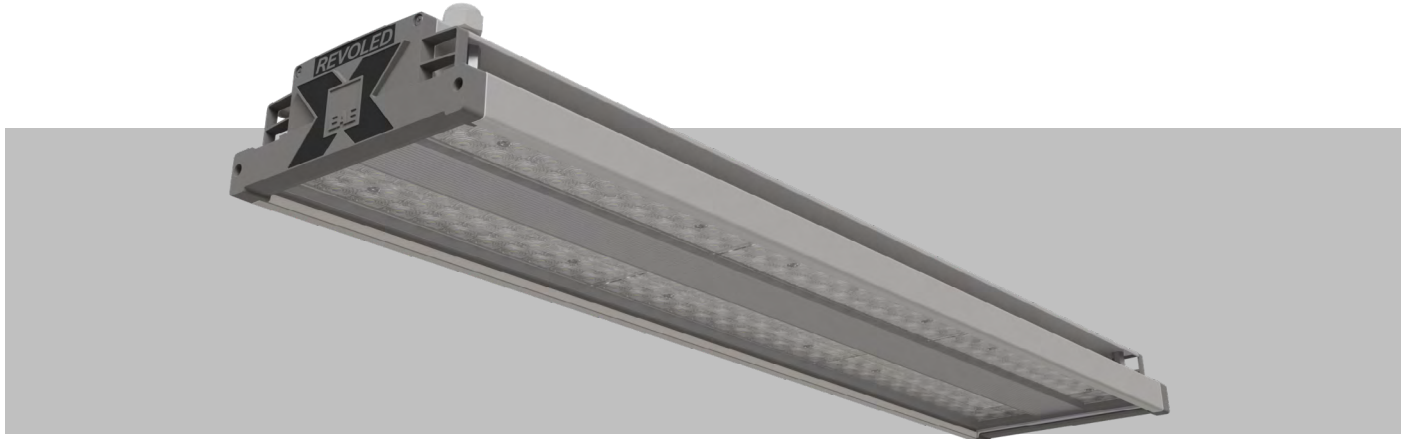

### Standard Features

Housing	Aluminium Extrusion Housing
Diffuser	Tempered glass
Optic	60° / 90°
IP	IP65
Installation	Surface mounted
Light Source	LED

### Optical & Electrical Features

Power	65W / 67W / 90W / 98W / 132W / 140W / 142W / 199W / 233W / 260W / 337W
Lumen	9600lm / 9230lm / 12100lm / 15000lm / 17600lm / 19800lm / 21200lm / 27100lm / 33100lm / 33600lm / 42100lm
Efficacy	125 - 151lm/W
Input Voltage	220-240 V
Frequency	50-60 Hz
Power Factor	> 0,9
Color Temperature	2700K / 3000K / 4000K / 5000K / 5700K / 6500K
CRI	>80

\*Technical specifications have ± 10 tolerance.

### Other Features & Conditions

Operating Temperature	-20°C / +40°C
Operating Temperature (ACK*)	+5°C / +35°C
Impact Resistance	IK07 / IK08 / IK09
LED Lifetime - L70	> 72.000 hour @Ta= 40 °C

\*Temperature values vary according to wattage values.

### Optional Features

Emergency Kit Options	1-3 hour
DALI Option	Yes

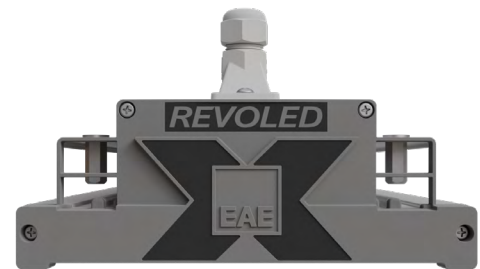

### Technical Drawing

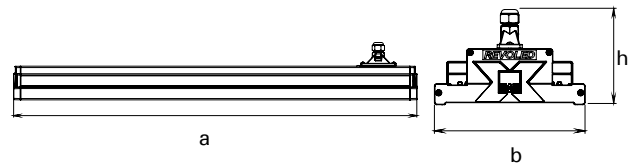

### Dimensions (mm)

	a	b	h
<b>65W</b>	615	203	128
<b>67W</b>	442	203	128
<b>90W</b>	615	203	128
<b>98W</b>	901,5	203	128
<b>132W</b>	615	203	128
<b>140W</b>	1188	203	128
<b>142W</b>	901,5	203	128
<b>199W</b>	901,5	203	128
<b>233W</b>	1188	203	128
<b>260W</b>	1188	203	128
<b>337W</b>	1474,5	203	128





-20 °C +40 °C

# REVOLED-X

## 50\*50 NG

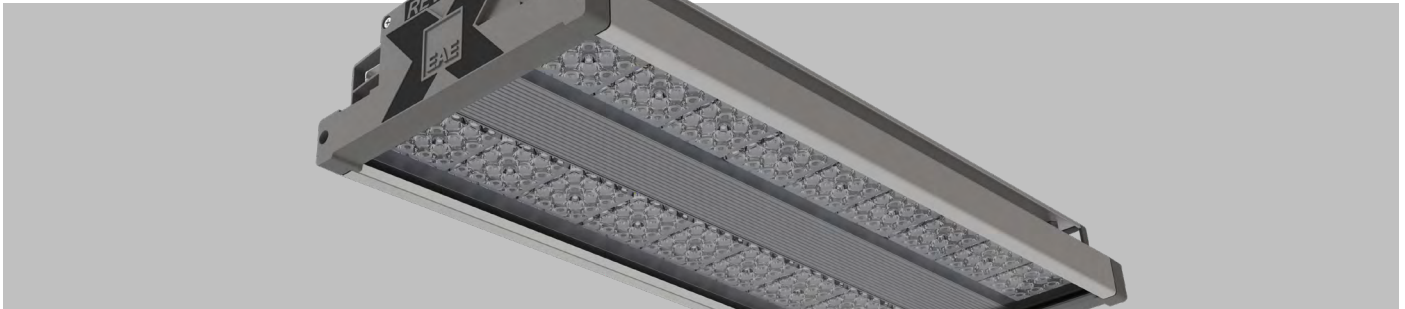

### Standard Features

Housing	Aluminium Extrusion Housing
Diffuser	Tempered glass
Optic	60° / 90°
IP	IP65
Installation	Surface mounted
Light Source	LED



### Optical & Electrical Features

Power	68W / 90W / 139W / 153W / 190W / 240W / 268W / 285W
Lumen	9568lm / 13084lm / 19114lm / 21608lm / 26659lm / 33185lm / 37369lm / 40782lm
Efficacy	138 - 143lm/W
Input Voltage	220-240 V
Frequency	50-60 Hz
Power Factor	> 0,9
Color Temperature	2700K / 3000K / 4000K / 5000K / 5700K / 6500K
CRI	> 80

\*Technical specifications have ± 10 tolerance.

### Technical Drawing

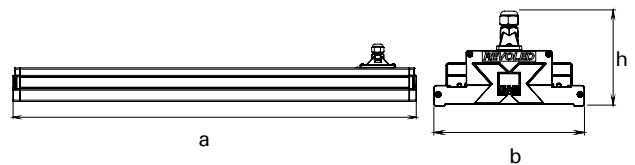

### Dimensions (mm)

	a	b	h
<b>68W</b>	456	203	128
<b>90W</b>	525	203	128
<b>139W</b>	508,5	203	128
<b>153W</b>	658,5	203	128
<b>190W</b>	761	203	128
<b>240W</b>	909,5	203	128
<b>268W</b>	964	203	128
<b>285W</b>	1167	203	128

### Other Features & Conditions

Operating Temperature	-20°C / +40°C
Operating Temperature (ACK*)	+5°C / +35°C
Impact Resistance	IK07 / IK08
LED Lifetime - L70	> 72.000 hour @Ta= 40 °C

\*Temperature values vary according to wattage values.

### Optional Features

Emergency Kit Options	1-3 hour
DALI Option	Yes

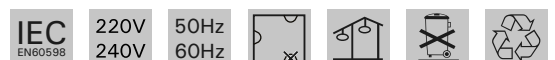

# SMARTLOG RF

Manager ideal lightning scenario for logistic warehouses with wireless communication (RF).



## RF CONTROL SCENARIOS

Automatic control opportunity sensitive to movement and daylight. The corridors where only movement is perceived ensure high energy saving actively. ON and OFF mode for all armatures.



## VERTICAL BUSBAR ASSEMBLY

If the rack layout architecture varies, it does not require intervention in the busbar installation. It provides low busbar cost with less busbar usage. Practical and fast assembly...



## SPECIAL OPTICAL REVOLVED-X

It offers high energy saving and low armature cost by ensuring ideal homogenic and lightness level with less number of armature.



REVOLVED-X 25x105° Optic

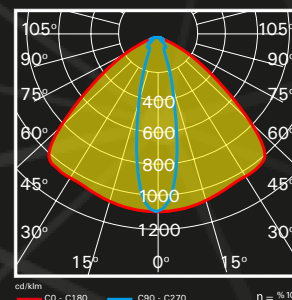
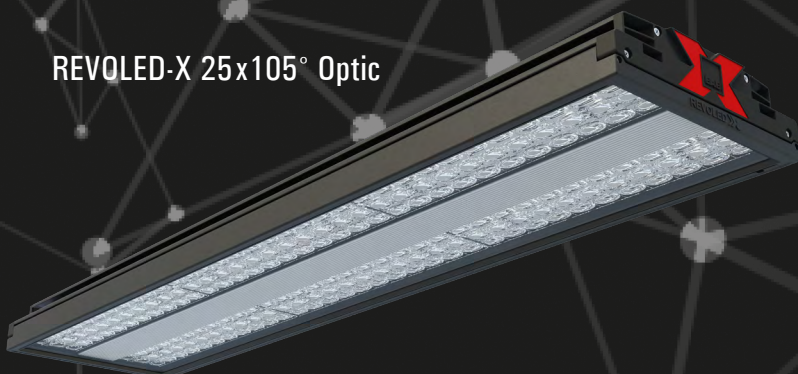

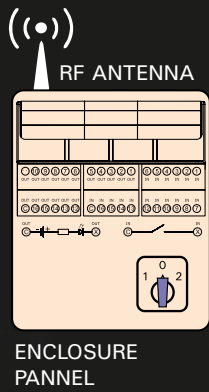
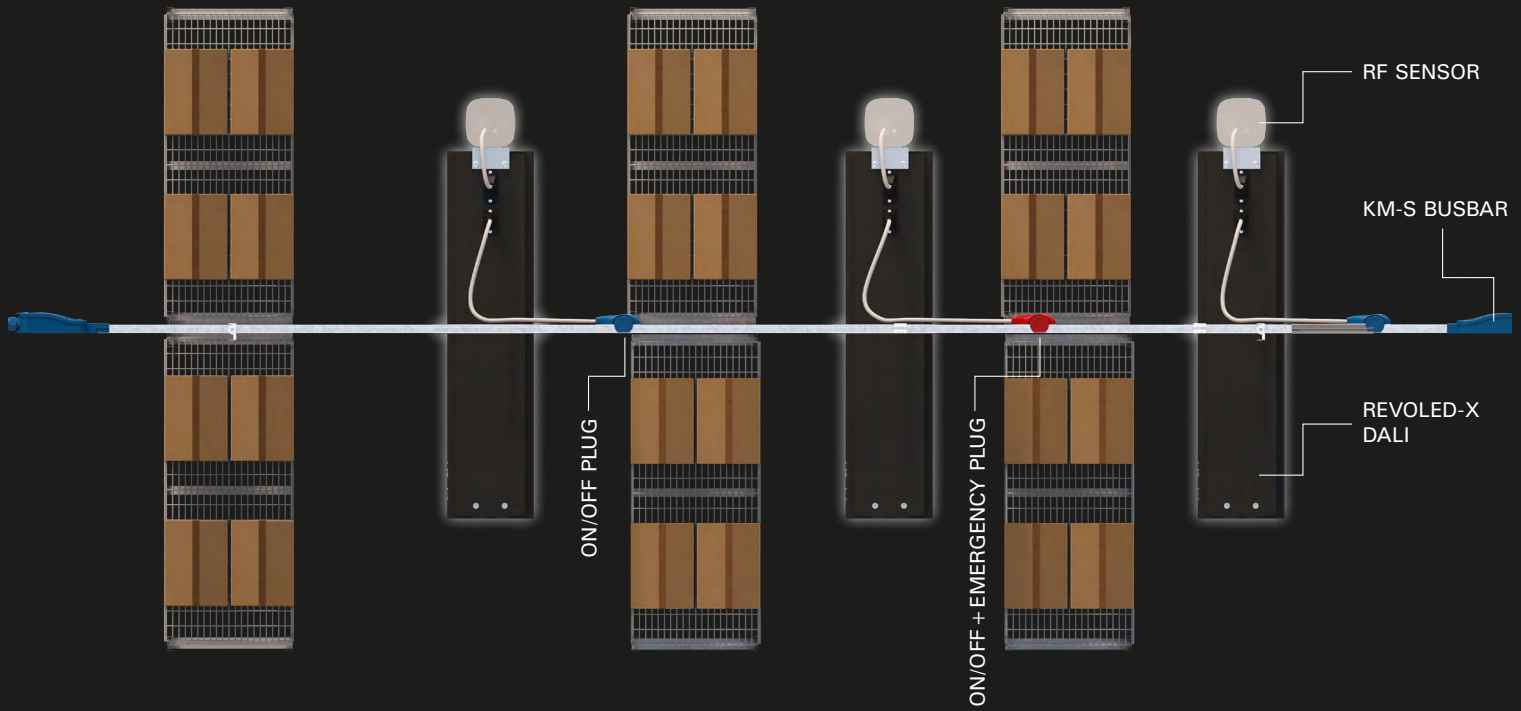

**PAKO SWICTH 3 STEP**  
 STEP '0' : FULL OFF  
 STEP '1' : FULL ON  
 STEP '2' : SENSOR ACTIVE / AUTOMATIC

**PRODUCTION / 4 PIN CONNECTOR**

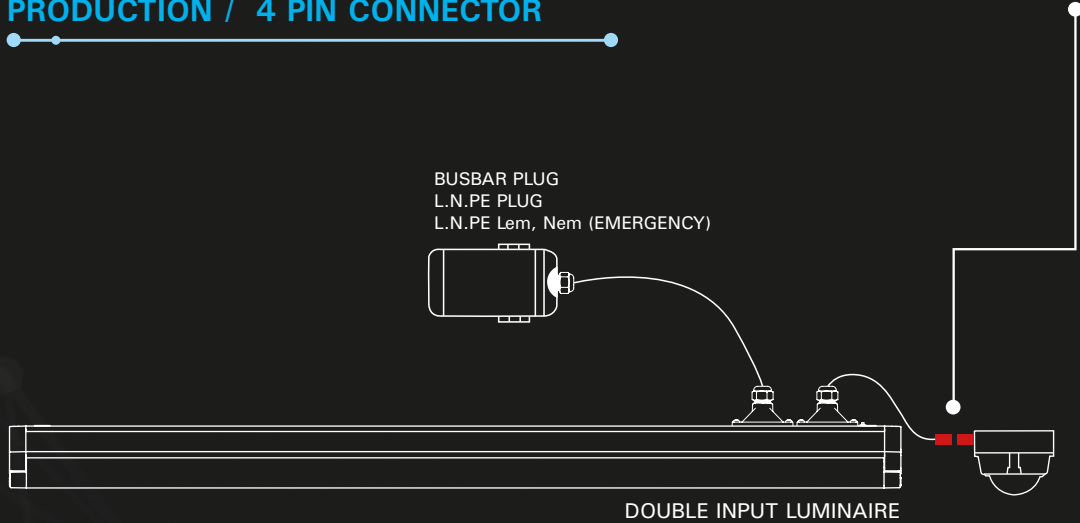

4 PIN CONNECTOR TECHNOC

MALE (sensor)  
 THB 4'LU DISI JAK IP66 TR  
 1024709

FEMALE (luminaire)  
 THB 4'LU ERKEK JAK IP66 TR  
 1023129

2 PIN for DALI  
 2 PIN for L/N

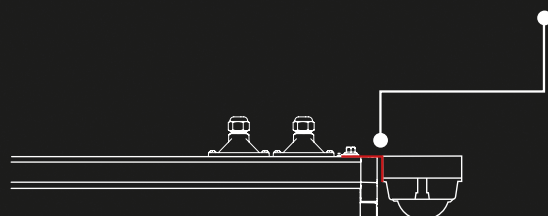

## TESTS AND CERTIFICATES

EAE Lighting bases its studies on "Light Engineering" upon the measurements and assessments carried out in its laboratory established in 2007.

Our laboratory has been accredited, namely officially recognized for the safety standard EN 6598 concerning lightening armatures in KEMA (purchased by DEKRA in 2009) of which the headquarters is situated in the Netherlands. Today, all tests including SMT, namely post-audited manufacturer tests of lightening armatures are carried out by EAE Lighting laboratory and the certification is performed by DEKRA. The members off laboratory team are also certified by KEMA (DEKRA).



**1983**  
Established

**%90** Domestic approved  
supplier approval



**33,6 Million ₺**  
R&D Investments



**362**  
Number of employees



**4,4 Million US Dollars**  
Infrastructure Investments,



**4344**  
(Person x Hour) Occupational  
Health and Safety Training,



**2.**  
Turkey Exporters Assembly  
(TIM)



**15966**  
(Person x Hour) Total training  
duration



**2860 GWh**  
Capacity of Renewable Ener-  
gy (GES)



**40**  
Number of countries of  
export



**911 Tonne**  
Recycled Waste Amount



**%91,33**  
Rate of customer satisfaction



**2.3 Million US Dollars**  
Renewable Energy (GES)  
Investments,



**1629 m3**  
Capacity of Rain Water Storage



**1046**  
(Person X Hour) Sustainability  
and Decarbonisation Training



## Tests

- Durability test and thermal test
- Thermal test
- Insulation resistance and electrical resistance
- Leakage current test
- Earthing schemes
- Mechanical tests
- Mechanical strength
- Screws, connections (mechanical) and fittings
- Vibration test
- Corrosion resistance
- Hangers, stabilizers and adjusters
- External and internal cable
- Protection against electric shock
- Photometric tests
- Goniophotometry 1 / 2
- Ulbricht sphere test
- Reflectance and Light Transmittance testing
- Photobiological testing
- Resistance to dust, solid objects and moisture
- Humidity cabinet
- Plastic testing
- Needle flame experiment
- Resistance to arc scar formation
- Reddened wire

## Certificates

- ISO 9001: 2015
- ISO 10002: 2018
- ISO 14001: 2015
- ISO 27001: 2013
- ISO 45001: 2018
- ISO 50001: 2018
- ISO 14064-1:2018
- ISO 28000: 2022
- TURKISH ACCREDITATION AGENCY
- DEKRA
- DIALUX PARTNER
- UL SOLUTIONS (DEMKO)

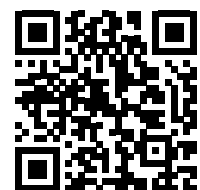

SCAN QR  
FOR CERTIFICATES

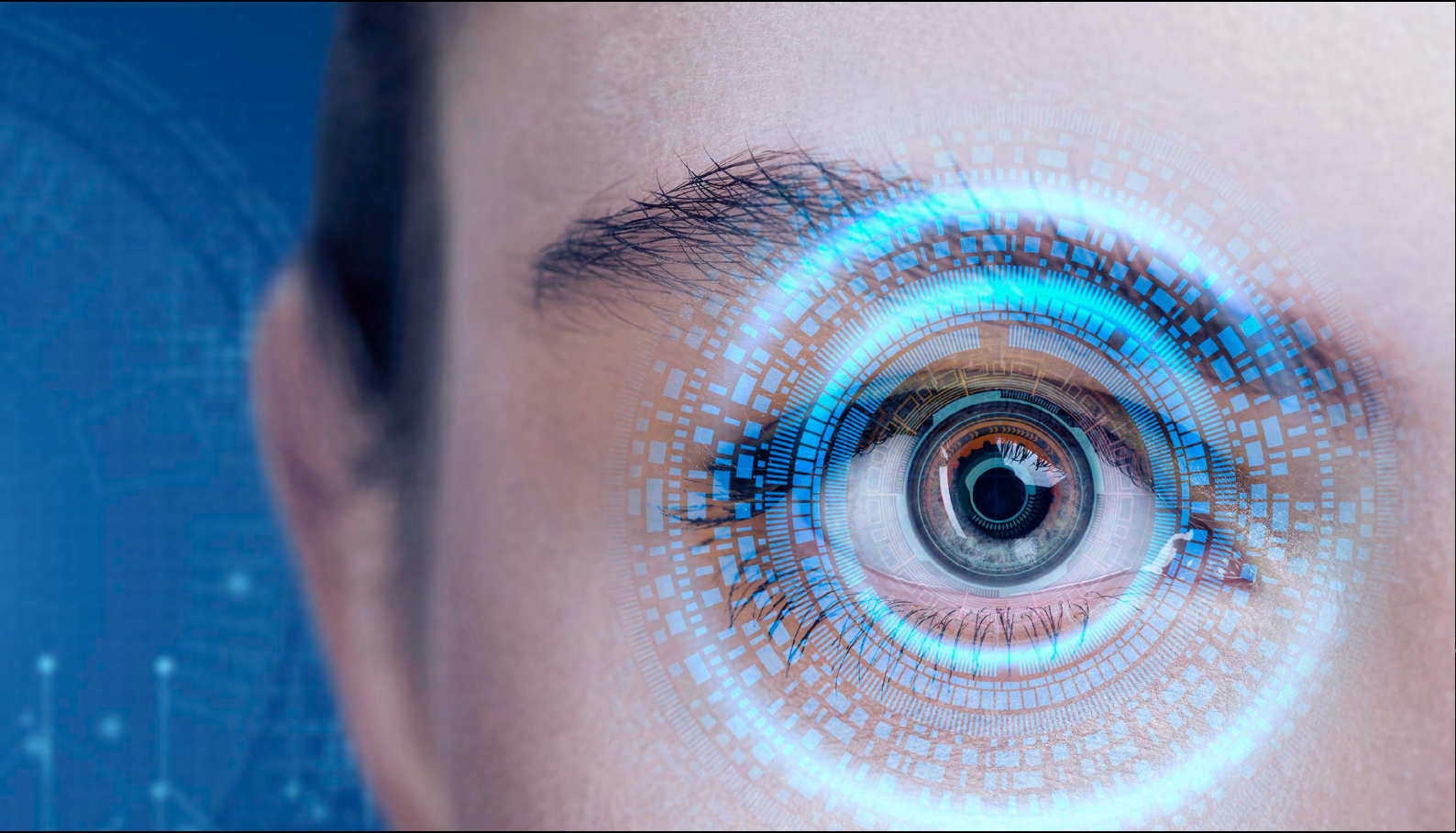

In lightening armatures with LED, photobiological safety standard must be necessarily applied against damage of light to eye and skin and blue light hazard.

Regarding photobiological safety, photobiological safety standard must be necessarily applied against damage of light to eye and skin and **BLUE LIGHT HAZARD** in solid state lightening products such as LEDs, LED modules, lightening armatures with LED.

Wavelength spectrum of armatures emitting white light in different CCT values are given in Figure 1. When wavelength spectrum is reviewed in lightening armatures (those with white light and / or narrow-band radiation), it is observed that the armatures can emit even a

very small amount of pre-violet and / or infrared radiation. It is known that the light emitted in the specified region leads to damage in eye (on cornea/retina) and skin. LEDs used in lightening armatures must be certified regarding that they do not damage especially eye and skin layer in photobiological aspect in accordance with the standards. According to the standard EN 62471 of the European Union in this regard, the products that radiate between 200nm and 3000nm are subject to the tests within the scope of this standard.



EAE Lighting photobiological test laboratory

### Revoled-X

The meeting of experience and the future in light engineering...

Revoled-X is a professional lighting solution which comes together EAE's industrial lighting experience with future technologies in an iconic and minimal housing.

Revoled-X ensures optimum lighting in all industrial plants thanks to its wide range of lumen packages, application-oriented optic design and housing with high mechanical resistance.

## INDUSTRIAL PRODUCTS



SROUND V.3

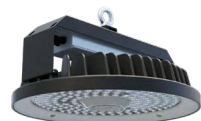

HBC

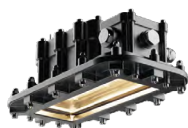

EX-LINE MINI



AGILITY



GALIS



ARKTOS



RA V.3



PROLIT PLUS



PROLIT V.3



PROLIT KOMPAKT



PROLIT-M PR V.2



GPRONA





## CONTACT

### FACTORY 1 - EAE KOCAELI

Makina İhtisas Org.San. Bol. 1. Cad. No: 4 Demirciler Mah. Dilovası / KOCAELI - TURKEY

Tel: +90 (262) 999 05 20

Fax: +90 (212) 549 37 90

### HEADQUARTERS

İkitelli Org. San. Bol. Eski Turgut Ozal Cad. Ziya Gokalp Mah. No: 20

Basaksehir / ISTANBUL - TURKEY

Tel: +90 212 413 21 00 (pbx)

Fax: +90 212 549 37 90

### EAE GERMANY

Stadionring 32, 40878 Ratingen, Germany

Esbade Herzog

Tel: +49 171 2968159

E-posta: [esbade.herzog@eaegroup.com](mailto:esbade.herzog@eaegroup.com)

### EAE ITALY

Via Visconti di Modrone 18 20122 Milano - Italy SEDE COMMERCIALE Via Degli Alpini 14

20090 Segrate (MI) / ITALY

Tel: +39 02.36555400

E-posta: [lighting@eaeitalia.it](mailto:lighting@eaeitalia.it)

### EAE RUSSIA OFFICE

ЕАЕ Электрик А.Ш. Россия, Москва, 117105, Варшавское Шоссе, 1 С6, БЦ W Plaza 2,

Anton Evdokimchik

Tel: +7 (495) 510-66-01

E-posta: [aevdokimchik@eaegroup.com](mailto:aevdokimchik@eaegroup.com)

# REVOLED



Come together experience with next

EAE LIGHTING-Brochure REVOLED-X - EN - Update Date: 1.05.2024  
EAE, is provided with the right to perform changes deemed necessary without notifying in advance.  
Please contact us for further information about products and details partaking in catalogue.



**EAE LIGHTING Inc.**

Ikitelli Organize Sanayi Bolgesi  
Eski Turgut Ozal Caddesi No:20  
Basaksehir / ISTANBUL - TURKEY  
Tel : +90 212 413 21 00 (pbx)  
Fax : +90 212 549 37 90  
[www.eaelighting.com](http://www.eaelighting.com)



*engineering the light*